

# AF 500H

Powerful 500 watt IP amplifier



Easy  
integration

Rugged  
housing

Loudspeaker  
line  
monitoring

IoIP<sup>®</sup> and  
SIP

ONVIF  
VMS  
integration

## Strong performance

The AF 500H provides a high output range and various connections – from a microphone input to a relay output. That's why the amplifier is universally suitable for any size of application – even for complex public address and Intercom solutions. In order to avoid cabling costs and be more flexible, the AF 500H is specifically optimised for installation either in a 19" rack or on-site.

Thanks to its high flexibility, the AF 500H is applicable in the most diverse areas where a reliable and powerful public address is needed. Thereby, this amplifier covers all requirements from public service facilities, critical infrastructure and smart city applications, office and school buildings up to the requirements of challenging and high-noise industrial environments.

## Features and highlights

- 500 W total output power
- Loudspeaker connectors for 70 V or 100 V powered loudspeakers
- Class-D amplifier optimised for high efficiency at low operating temperatures
- Full IoIP<sup>®</sup> and SIP support
- Support of ONVIF Profile S for unidirectional audio transmission allows either audio announcements via a VMS (video management systems) or audio streaming to a VMS
- Short-circuit and over-range protected
- Line monitoring between amplifier and Intercom Server
- Loudspeaker line monitoring (requires licence L-AF-LM)
- Up to 16 kHz transmission bandwidth for highest speech intelligibility
- Easy integration in existing systems
- High level of reliability
- Support of Intercom station features (e.g. two-way communication and talk-back functionality, audio monitoring, IVC and equalizer)
- Installation in a 19" rack or on-site
- Rugged metal housing

# AF 500H

## Technical specifications



### Technical data

<b>IP rating:</b>	IP20 (acc. EN 60529)
<b>Output power:</b>	500 W <sub>RMS</sub>
<b>Power supply <sup>1)</sup>:</b>	AC main power supply: 100–240 VAC (50–60 Hz, max. 680 W) DC backup power supply: 24 VDC (21–28 VDC, max. 25 A) <sup>2)</sup>
<b>Average power consumption (acc. to IEC-60268-3):</b>	idle mode: 25 W (AC main power supply), 17 W (DC backup power supply) active mode (1 kHz sine @ –10 dB): 89 W (AC main power supply), 72 W (DC backup power supply)
<b>Protocols (IoIP):</b>	IoIP protocol based on UDP/IP
<b>Protocols (SIP):</b>	IPv6, IPv4, TCP, UDP, HTTP (RFC 2617, RFC 3310), RTP (RFC 3550), RTCP, DHCP, SDP (RFC 2327), SIP (RFC 3261), SNMPv2, STUN, TFTP, URI (RFC 2396), DTMF Decoding (RFC 2876, RFC 2833), SIP User Agent (UDP RFC 3261), SIP Refer Method (RFC 3515)
<b>Codecs (SIP):</b>	G.711 a-Law, G.711 μ-Law, G.722
<b>ONVIF specification:</b>	ONVIF Profile S for unidirectional audio
<b>IoIP audio bandwidth:</b>	16 kHz
<b>SIP audio bandwidth:</b>	7 kHz
<b>Total harmonic distortion (THD+N):</b>	< 0.2% at 1 kHz sine at 500 W
<b>Signal-to-noise ratio (SNR):</b>	amplifier: > 110 dB codec G.722: > 84 dB
<b>Cabling:</b>	min. Cat. 5
<b>Connection:</b>	2 RJ45 modular jacks (IP uplink and IP downlink) outputs, inputs, microphone <sup>3)</sup> , line out: pluggable screw terminals (0.08–1.5 mm <sup>2</sup> /AWG 28–16) loudspeaker output: pluggable screw terminals (0.75–4 mm <sup>2</sup> /AWG 20–12, class 2 wiring) AC main power supply (IEC-60320-C14) DC backup power supply: 6 mm <sup>2</sup> /AWG 10
<b>Loudspeaker output:</b>	100 V, switchable to 70 V via software
<b>Microphone input:</b>	sensitivity: –43 dBV/Pa feeding voltage: 2.5 V at 3.3 kΩ
<b>Line output:</b>	nominal level 0 dBu (0.775 V)
<b>Inputs:</b>	2 inputs for floating contacts (detection of 5 input states)
<b>Outputs:</b>	relay output (changeover contact): max. 60 W (DC)/ 37.5 VA (AC), max. 2 A <sup>4)</sup> , max. 60 VDC/30 VAC <sub>eff</sub> expected life: min. 10 <sup>5</sup> (30 VDC/2 A), 5 x 10 <sup>5</sup> (30 VDC/1 A)
<b>Control input:</b>	0–10 V (for remote volume control)
<b>Operating temperature range:</b>	–10 °C to +55 °C (+14 °F to +131 °F)
<b>Storage temperature range:</b>	–25 °C to +70 °C (–13 °F to +158 °F)
<b>Relative humidity:</b>	up to 95%, non-condensing
<b>Approvals and compliances:</b>	EN 61000-6-2, EN 61000-6-3, EN 55032 Class B, EN 55024, EN 60529 IP20 IEC/EN/UL 62368-1 and CB-Scheme (by UL) UL LISTED, FCC Part 15 Class B, ICES-003 Class B,
<b>Dimensions (W x H x D):</b>	401 x 44 x 267 mm (15.79 x 1.73 x 10.51 in)
<b>Weight incl. package:</b>	approx. 4,100 g (9.1 lbs)

### Extent of supply

- Amplifier
- Connector (DC backup power supply)
- 4 rubber feet
- Device identification document
- Short reference

### Line length in LAN

The maximum line length of Cat. 5 cabling in a LAN is 100 m (328 ft) – e.g. from switch to amplifier.

### Power cable

For the AF 500H, the power cable with country-specific plug is available separately:

- C-KAB-C13-AU (Australia)
- C-KAB-C13-EU (Europe)
- C-KAB-C13-UK (United Kingdom)
- C-KAB-C13-US (USA)

<sup>1)</sup> For power supply connections, use cables suitable for at least 60 °C.

<sup>2)</sup> The DC backup power supply input may only be connected to an ES1 circuit as per IEC/EN 62368-1 (cf. SELV acc. to EN 60950-1).

<sup>3)</sup> In order to fulfil the electromagnetic compatibility directive, the cable of a connected microphone has to be less than 30 m and shielded.

<sup>4)</sup> For the north American market (UL 62368-1 compliance), the max. supported current is limited to 1 A (AC)/0.6 A (DC).

## System overview

The following illustration shows an example of the integration of an AF 500H amplifier into an IP network.

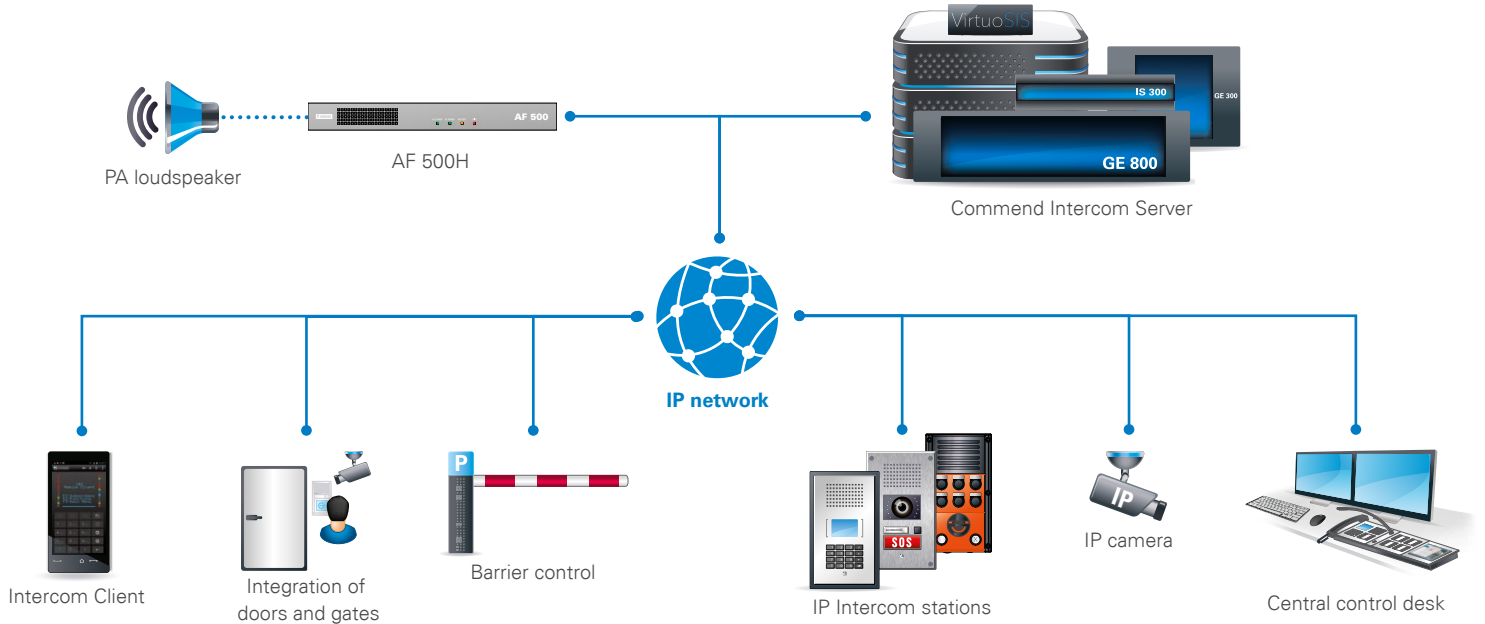

## System requirements

### VoIP

#### Intercom Server

- GE 800 (min. PRO 800 6.3) with G8-IP (min. G3-8-IP 6.6D) or
- GE 300 (min. PRO 800 6.3) with G3-IP (min. G3-8-IP 6.6D) or
- IS 300 (min. PRO 800 6.3) or
- VirtuoSIS (min. 9.0) or
- GE 700 with GE700-UPG (min. PRO 800 6.3) with G7-DSP-IP

#### Configuration software

- min. CCT 800 9.0
- IP Station Config (included in setup of CCT 800)

### SIP

- S3/S6/VirtuoSIS (min. 9.0) or
- Compatible SIP server (see compatibility list “**Interoperability SIP**”) or
- Serverless operation

### Device firmware

- VoIP-Device (min. version 8.0)
- SIP Series (min. version 4.1)

### ATTENTION

- Downgrading to firmware version lower than VoIP-Device 8.0 is not supported.
- Downgrading to firmware version lower than SIP Series 4.1 is not supported.

## Requirements to the network for use as SIP device

### Ports

- The configuration via the web interface is done via TCP port 80 (cannot be configured).
- The communication from the SIP device to the SIP server is done via the following ports (both are configurable):
  - SIP: UDP port 5060
  - RTP: UDP port 16384 (incoming)

## Requirements to the network for use as VoIP device

### IP addresses and ports

- For the AF 500H, the DHCP functionality is available. If DHCP is not used, the AF 500H must have a fixed IP address.
- In case of a changing public IP address, dynamic registration of an AF 500H is possible.
- Communication from the program IP Station Config is done via port 16399 (cannot be configured).
- Communication from the AF 500H to the Intercom Server (UDP protocol) is done via port 16400 (configurable).

### QoS requirements

- One-way delay max. 100 ms
- Delay jitter max. 50 ms
- 0% packet loss for perfect audio quality

### Bandwidth

For further information on bandwidth, see “**VoIP Technology Guideline**”



# AF 500H

## Installation instructions

### Mounting instructions

- Do not place the device in locations where it may be wet or damp. Also avoid locations with increased dust formation, high humidity or high ambient temperature.
- If the device is used with the DC backup power supply, it has to be connected to protective earth (⚡). Size the grounding cable according to the national installation requirements. The cable cross-section must be at least that of the backup wire.
- The electrical connections must face downwards when mounting the device on a wall.
- Use shielded Ethernet cables only.
- Do not cover the device.
- Before using the device, make sure all cables are connected correctly and are not damaged.
- If more than three devices are installed stacked in a 19" rack, it is recommended to leave at least one height unit free after three devices due to heat generation.
- To be able to connect the DC backup power supply, the cover of the jack has to be removed.
- Rack Mounting
  - Use external or internal speaker wiring, provide DC backup supply or AC supply, limit access to the device to skilled persons only.
  - Elevated Operating Ambient – If installed in a closed or multi-unit rack assembly, it must be placed in a restricted access area. The operating ambient temperature of the rack environment may be greater than room ambient. Therefore, consideration should be given to installing the equipment in an environment compatible with the maximum ambient temperature (T<sub>ma</sub>) specified by the manufacturer.
  - Reduced Air Flow – Installation of the equipment in a rack should be such that the amount of air flow required for safe operation of the equipment is not compromised.
  - Mechanical Loading – Mounting of the equipment in the rack should be such that a hazardous condition is not achieved due to uneven mechanical loading.
  - Circuit Overloading – Consideration should be given to the connection of the equipment to the supply circuit and the effect that overloading of the circuits might have on overcurrent protection and supply wiring. Appropriate consideration of equipment nameplate ratings should be used when addressing this concern.
  - Reliable Earthing – Reliable earthing of rackmounted equipment should be maintained. Particular attention should be given to supply connections other than direct connections to the branch circuit (e.g. use of power strips).
- Wall mounting
  - With internally or externally mounted speakers: Install the device in a restricted access area, provide DC backup supply or AC supply, limit access to the device to skilled persons only.
  - With internally mounted speakers: Provide AC supply with no DC backup supply (only with cover mounted), access to the device for untrained persons is tolerable.
- Table mounting
  - Allowed with internally mounted speakers only, provide AC supply with no DC backup supply (only with cover mounted), access to the device for untrained persons is tolerable.
- This equipment has been tested and found to comply with the limits for a Class B digital device, pursuant to part 15 of the FCC Rules. These limits are designed to provide reasonable protection against harmful interference in a residential installation. This equipment generates, uses and can radiate radio frequency energy and, if not installed and used in accordance with the instructions, may cause harmful interference to radio communications. However, there is no guarantee that interference will not occur in a particular installation. If this equipment does cause harmful interference to radio or television reception, which can be determined by turning the equipment off and on, the user is encouraged to try to correct the interference by one or more of the following measures:
  - Reorient or relocate the receiving antenna.
  - Increase the separation between the equipment and receiver.
  - Connect the equipment into an outlet on a circuit different from that to which the receiver is connected.
  - Consult the dealer or an experienced radio/TV technician for help.

### Safety instructions

- This device shall be installed or replaced by trained and qualified personnel only.
-  Caution: Exposed connections or cables. During operation, up to 100 volts may be present. Touching uninsulated terminals or wiring may result in an unpleasant sensation.
-   Caution: Shock hazard. Disconnect all power sources from the device before doing any maintenance work.
- To safely disconnect the device from the mains, switch off the device via the power switch and disconnect the DC-IN plug (DC backup power supply). For this reason, the rear of the device must be easily accessible.
- For operation via the AC main power supply, make sure that the PE contact of the power cable is present and connected to protective earth on the source side.
- Do not make any modifications to the device and do not open the housing.
- All connections of the device are intended for installation within a building or a grounding system.
- For connections leaving the building, protective measures must be taken according to the national installation requirements.
- A protective earth conductor is required. It must be connected using a fixed connection, a screw terminal or the plug of the AC main power supply. When the DC backup power supply is connected, hard wiring of the protective earth conductor is required.
- Check the air filter frequently and clean it if necessary. The air filter is located at the bottom of the device directly below the ventilation holes on the front. It can be pulled out from the housing without the use of tools.
- For ventilation clearance, min. 100 mm space has to be left on the front and rear of the device.

## Connection

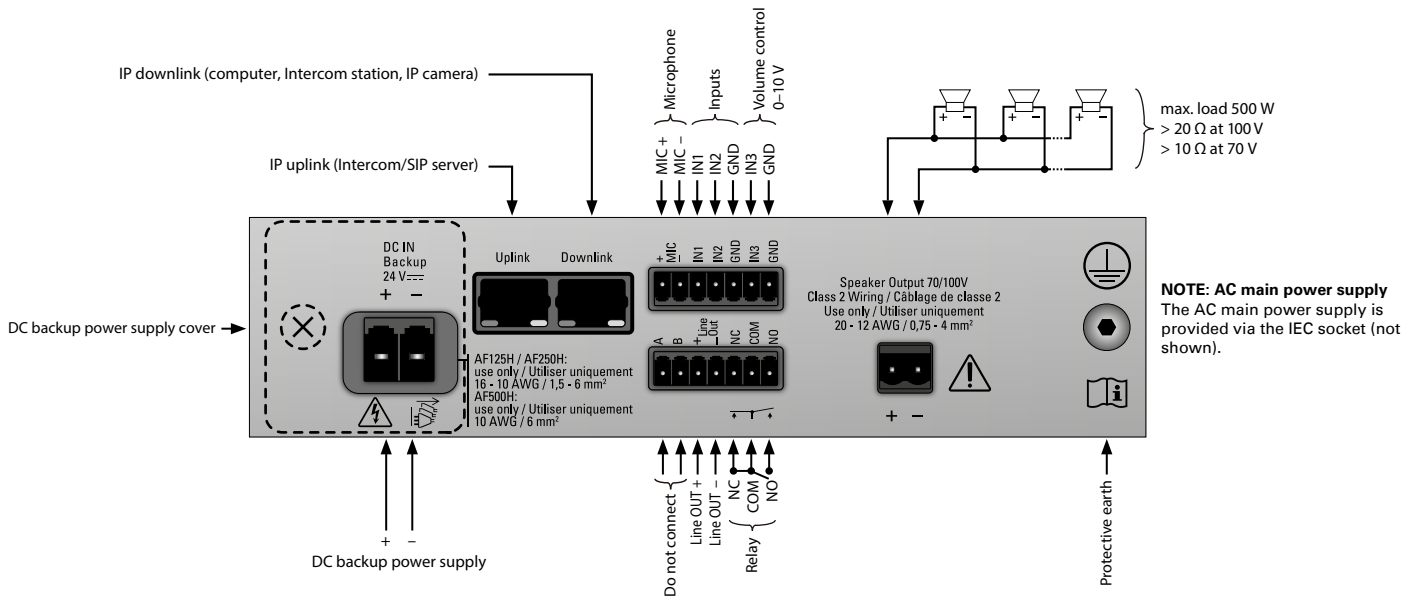

## Mounting

- For wall mounting, a wall mount kit PF-WM is required (available separately; for mounting, see short reference "PF-WM").
- For rack mounting, a 19" rack mount kit PF-RM-1HE is required (available separately; for mounting, see short reference "PF-RM-1HE").

## Dimensions front panel

Measuring units in mm (in), not to scale!

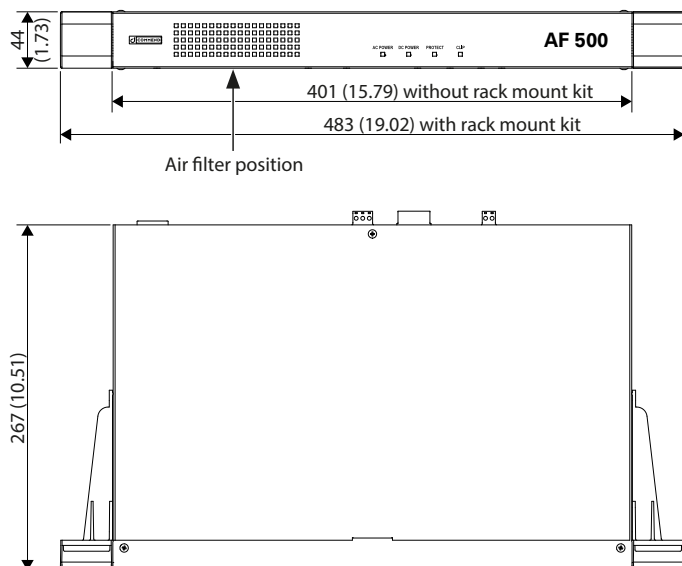

## Volume settings

The volume can be controlled via CCT 800 in IoIP operation mode and via the web interface in SIP operation mode or via the volume control ("IN3").

## Microphone loudspeaker distance for IVC

If IVC (Intelligent Volume Control) is used, the distance between microphone and the nearest loudspeaker has to be less than 3 m. In this way, an unwanted increase of the loudspeaker volume level is prevented.

## LED status indication

### LED "AC POWER"

- Permanent green: AC main power supply applied

### LED "DC POWER"

- Permanent green: DC backup power supply applied

### LED "PROTECT"

- Permanent yellow: amplifier fault detected
- Yellow blinking: loudspeaker output fault detected by means of line monitoring or earth fault

### LED "CLIP"

- Flickering red: clipping detected

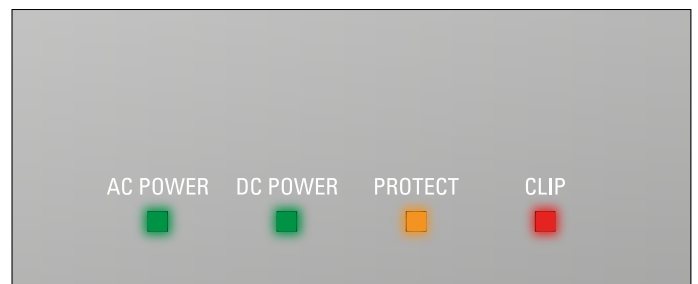

# AF 500H

## Complementary information

### Loudspeaker line monitoring

#### Functionality

With loudspeaker line monitoring, it is possible to detect the following errors at the loudspeaker output:

- **Short-circuit** (impedance  $< 20 \Omega$  at 100 V/ $< 10 \Omega$  at 70 V)
  - ATTENTION: Loop impedance**  
The loop impedance for the loudspeaker cable must be lower than  $20 \Omega$  at 100 V/ $10 \Omega$  at 70 V in order to be able to detect short-circuits.
- **Short circuit to ground** (impedance to ground  $< 50 \text{ k}\Omega$ )
- **Disconnection** (impedance  $> 1 \text{ k}\Omega$ )
- **Impedance changing** ( $\pm 10\%$ ,  $\pm 20\%$ ,  $\pm 30\%$ ,  $\pm 40\%$  and  $\pm 50\%$ )

Loudspeaker line monitoring is based on an impedance measurement with adjustable tolerance values of  $\pm 10\%$ ,  $\pm 20\%$ ,  $\pm 30\%$ ,  $\pm 40\%$  and  $\pm 50\%$ . These values obviate against errors depending on temperature value changing, deterioration and so on. During the impedance measurement, a pilot signal (67 Hz with  $-23 \text{ dBFS}$ ) is put out. The measurement is also carried out during audio output. An error is displayed with measurement cycles every 60 seconds.

#### System requirements

##### Software

- loIP operation: licence "L-AF-LM"
- SIP operation: no licence required

#### Configuration (loIP operation)

##### ATTENTION: Required configuration

For the configuration of loudspeaker line monitoring, an active connection between CCT 800 and the amplifier is required.

- Go to: **Subscriber > Station Properties > AF series > AF 500H > tab Line Monitoring**
- Activate the checkbox **Line Monitoring**.
- In the drop-down list **Line**, select the used line type (" $70 \text{ V}$ " or " $100 \text{ V}$ ").
- In the drop-down list **Tolerance**, select the tolerance value for measurements. Within this tolerance, a deviation from the reference value will not be interpreted as error. It is recommended to set the tolerance value to  $\pm 30\%$ .
- Click on **Measure ...** to measure the impedance of the loudspeaker line. The measurement is displayed in the filed "Impedance".
- Click on **Accept ...** to set the current measured value as nominal value. The current nominal value is displayed in the filed "Impedance nominal value".
- After the configuration, send the CCT 800 configuration to the Intercom Server.

#### Quality tested. Reliable. Smart.

COMMEND products are developed and manufactured by Commend International in Salzburg, Austria.

The development and manufacturing processes are certified in accordance with **EN ISO 9001:2015**.



The technical data contained herein has been provided solely for informational purposes and is not legally binding. Subject to change, technical or otherwise. loIP®, OpenDuplex® and Commend® are trademarks registered by Commend International GmbH. All other brands or product names are trademarks or registered trademarks of the respective owner and have not been specifically earmarked.

#### A strong worldwide network

COMMEND is represented all over the world by local Commend Partners and helps to improve security and communication with tailored Intercom solutions.

[www.commend.com](http://www.commend.com)